

Polar™ Power MOSFET

HiPerFET™

IXFL30N120P

N-Channel Enhancement Mode
Avalanche Rated
Fast Intrinsic Diode

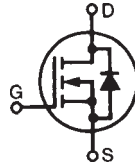

$V_{DSS} = 1200V$
 $I_{D25} = 18A$
 $R_{DS(on)} \leq 380m\Omega$
 $t_{rr} \leq 300ns$

ISOPLUS i5-Pak™ (HV)

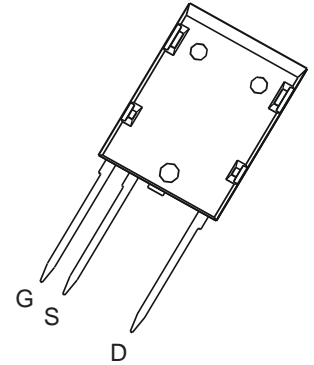

G = Gate
S = Source
D = Drain

Symbol	Test Conditions	Maximum Ratings	
V_{DSS}	$T_J = 25^\circ C$ to $150^\circ C$	1200	V
V_{DGR}	$T_J = 25^\circ C$ to $150^\circ C$, $R_{GS} = 1M\Omega$	1200	V
V_{GSS}	Continuous	± 30	V
V_{GSM}	Transient	± 40	V
I_{D25}	$T_C = 25^\circ C$	18	A
I_{DM}	$T_C = 25^\circ C$, pulse width limited by T_{JM}	80	A
I_A	$T_C = 25^\circ C$	15	A
E_{AS}	$T_C = 25^\circ C$	1.5	J
dV/dt	$I_S \leq I_{DM}$, $V_{DD} \leq V_{DSS}$, $T_J \leq 150^\circ C$	15	V/ns
P_D	$T_C = 25^\circ C$	357	W
T_J		-55 ... +150	$^\circ C$
T_{JM}		150	$^\circ C$
T_{stg}		-55 ... +150	$^\circ C$
T_L	Maximum lead temperature for soldering	300	$^\circ C$
T_{SOLD}	Plastic body for 10s	260	$^\circ C$
V_{ISOL}	50/60 Hz, RMS, 1 minute	2500	V~
	$I_{ISOL} \leq 1mA$ $t = 1s$	3000	V~
F_C	Mounting force	40..120/4.5..27	N/lb.
Weight		8	g

Features

- UL recognized package
- Silicon chip on Direct-Copper-Bond substrate
 - High power dissipation
 - Isolated mounting surface
 - 2500V electrical isolation
- Unclamped Inductive Switching (UIS) rated
- Low package inductance
 - easy to drive and to protect
- Fast intrinsic diode

Advantages

- Easy to mount
- Space savings
- High power density

Applications:

- High Voltage Switched-mode and resonant-mode power supplies
- High Voltage Pulse Power Applications
- High Voltage Discharge circuits in Lasers Pulsers, Spark Igniters, RF Generators
- High Voltage DC-DC converters
- High Voltage DC-AC inverters

Symbol	Test Conditions ($T_J = 25^\circ C$, unless otherwise specified)	Characteristic Values		
		Min.	Typ.	Max.
BV_{DSS}	$V_{GS} = 0V$, $I_D = 3mA$	1200		V
$V_{GS(th)}$	$V_{DS} = V_{GS}$, $I_D = 1mA$	3.5		6.5 V
I_{GSS}	$V_{GS} = \pm 30V$, $V_{DS} = 0V$			± 200 nA
I_{DSS}	$V_{DS} = V_{DSS}$ $V_{GS} = 0V$ $T_J = 125^\circ C$			50 μA 5 mA
$R_{DS(on)}$	$V_{GS} = 10V$, $I_D = 15A$, Note 1			380 m Ω

Symbol	Test Conditions ($T_J = 25^\circ\text{C}$ unless otherwise specified)	Characteristic Values		
		Min.	Typ.	Max.
g_{fs}	$V_{DS} = 20\text{V}, I_D = 15\text{A}$, Note 1	13	22	S
C_{iss}	$V_{GS} = 0\text{V}, V_{DS} = 25\text{V}, f = 1\text{MHz}$		19	nF
C_{oss}			960	pF
C_{rss}			25	pF
R_{Gi}	Gate input resistance		1.70	Ω
$t_{d(on)}$	Resistive Switching Times $V_{GS} = 10\text{V}, V_{DS} = 0.5 \cdot V_{DSS}, I_D = 15\text{A}$ $R_G = 1\Omega$ (External)		57	ns
t_r			60	ns
$t_{d(off)}$			95	ns
t_f			56	ns
$Q_{g(on)}$	$V_{GS} = 10\text{V}, V_{DS} = 0.5 \cdot V_{DSS}, I_D = 15\text{A}$		310	nC
Q_{gs}			104	nC
Q_{gd}			137	nC
R_{thJC}				0.35 $^\circ\text{C/W}$
R_{thCS}		0.15		$^\circ\text{C/W}$

Symbol	Test Conditions ($T_J = 25^\circ\text{C}$ unless otherwise specified)	Characteristic Values		
		Min.	Typ.	Max.
I_S	$V_{GS} = 0\text{V}$			30 A
I_{SM}	Repetitive, pulse width limited by T_{JM}			120 A
V_{SD}	$I_F = I_S, V_{GS} = 0\text{V}$, Note 1			1.5 V
t_{rr}	$I_F = 15\text{A}, -di/dt = 100\text{A}/\mu\text{s}$ $V_R = 100\text{V}, V_{GS} = 0\text{V}$			300 ns
Q_{RM}			1.6	μC
I_{RM}			14	A

Note 1: Pulse test, $t \leq 300\mu\text{s}$; duty cycle, $d \leq 2\%$.

ISOPLUS i5-Pak™ HV (IXFL) Outline

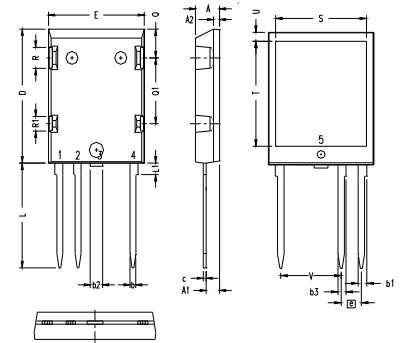

Note: Bottom heatsink meets 2500 Vrms isolation to the other pins.

SYM	INCHES		MILLIMETERS	
	MIN	MAX	MIN	MAX
A	.190	.205	4.83	5.21
A1	.102	.118	2.59	3.00
A2	.046	.055	1.17	1.40
b	.045	.055	1.14	1.40
b1	.063	.072	1.60	1.83
b2	.100	.110	2.54	2.79
b3	.058	.068	1.47	1.73
c	.020	.029	0.51	0.74
D	1.020	1.040	25.91	26.42
E	.770	.799	19.56	20.29
e	.150 BSC		3.81 BSC	
L	.780	.820	19.81	20.83
L1	.080	.102	2.03	2.59
Q	.210	.235	5.33	5.97
Q1	.490	.513	12.45	13.03
R	.150	.180	3.81	4.57
R1	.100	.130	2.54	3.30
S	.668	.690	16.97	17.53
T	.801	.821	20.34	20.85
U	.065	.080	1.65	2.03
V	.440	.460	11.18	11.68

IXYS reserves the right to change limits, test conditions, and dimensions.

IXYS MOSFETs and IGBTs are covered by one or more of the following U.S. patents:	4,835,592	4,931,844	5,049,961	5,237,481	6,162,665	6,404,065 B1	6,683,344	6,727,585	7,005,734 B2	7,157,338B2
	4,850,072	5,017,508	5,063,307	5,381,025	6,259,123 B1	6,534,343	6,710,405 B2	6,759,692	7,063,975 B2	
	4,881,106	5,034,796	5,187,117	5,486,715	6,306,728 B1	6,583,505	6,710,463	6,771,478 B2	7,071,537	

**Fig. 1. Output Characteristics
@ 25°C**

**Fig. 2. Extended Output Characteristics
@ 25°C**

**Fig. 3. Output Characteristics
@ 125°C**

**Fig. 4. $R_{DS(on)}$ Normalized to $I_D = 15\text{A}$ Value
vs. Junction Temperature**

**Fig. 5. $R_{DS(on)}$ Normalized to $I_D = 15\text{A}$ Value
vs. Drain Current**

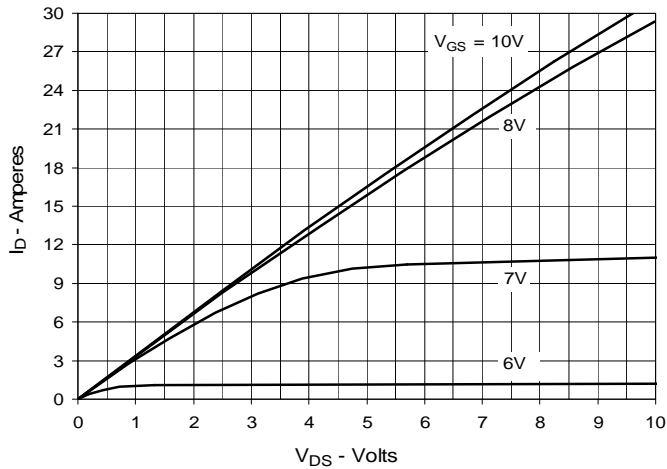
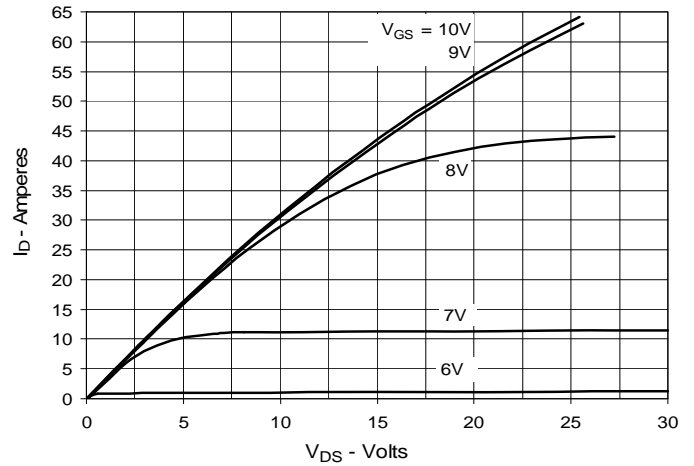
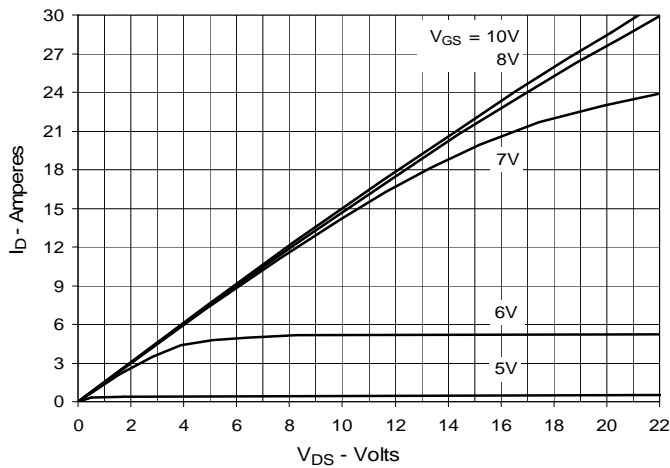
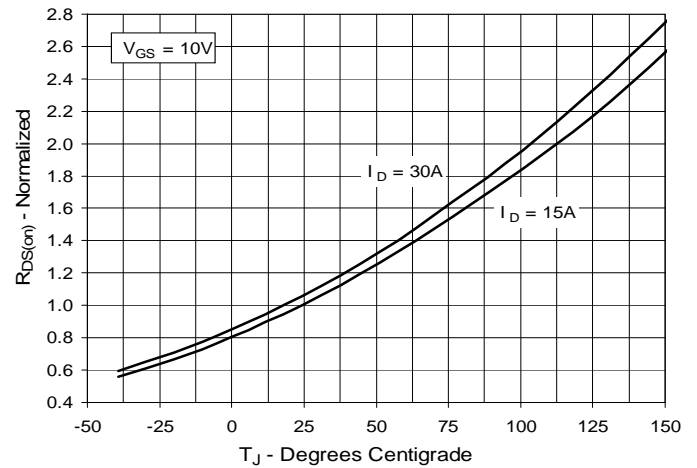
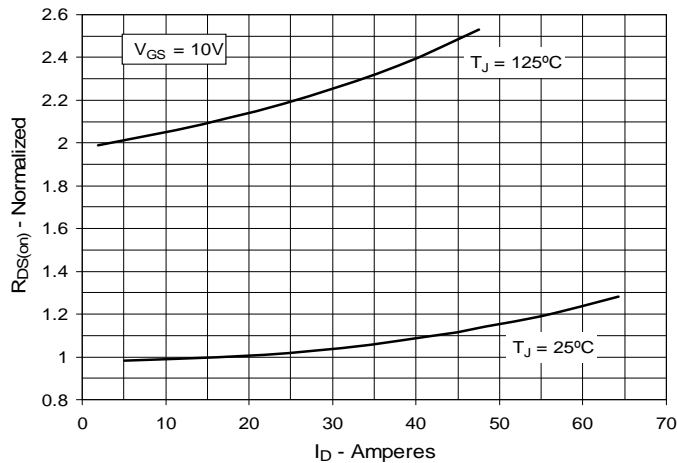
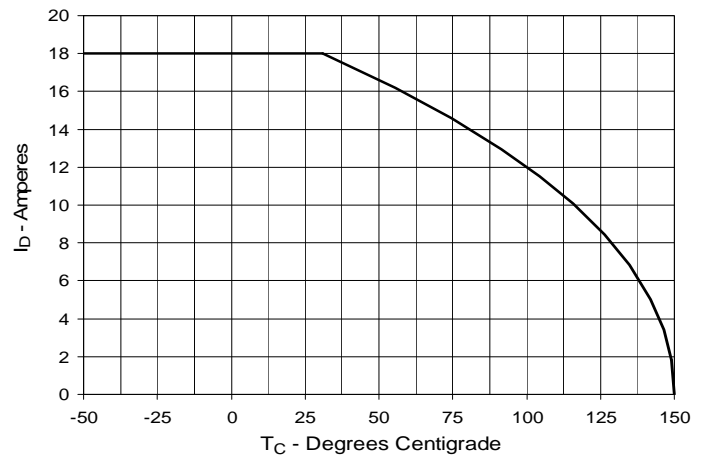
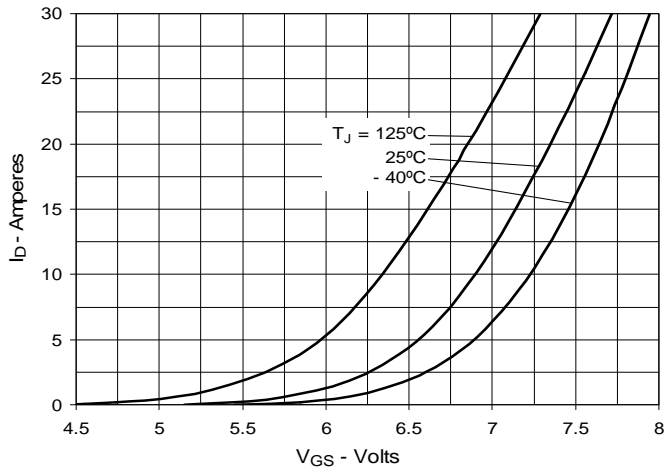
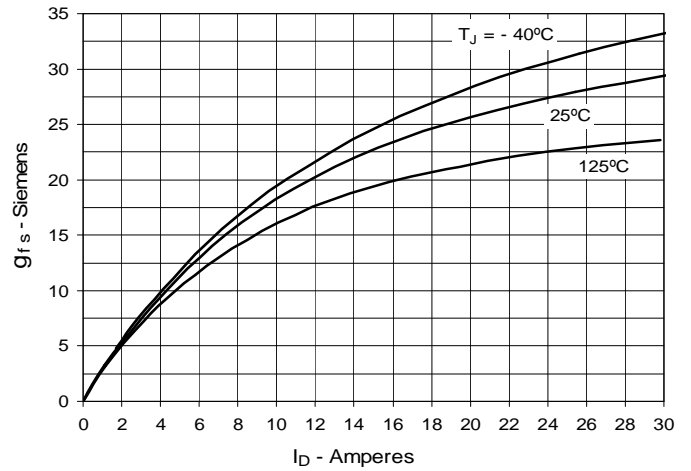
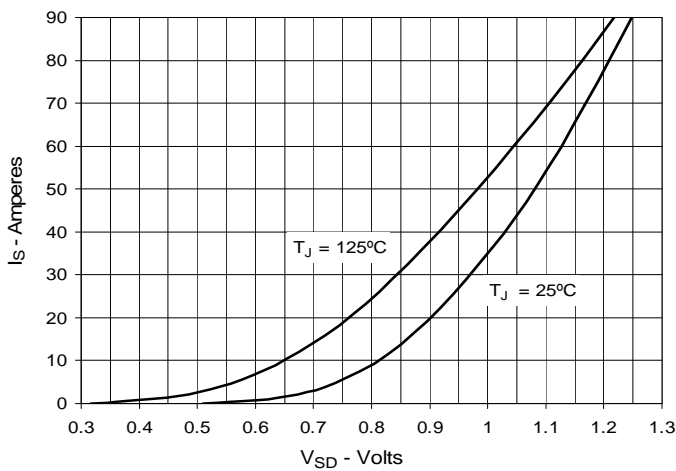
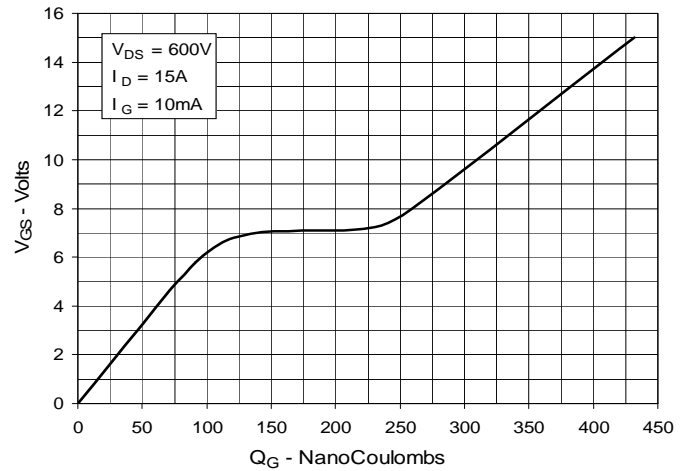
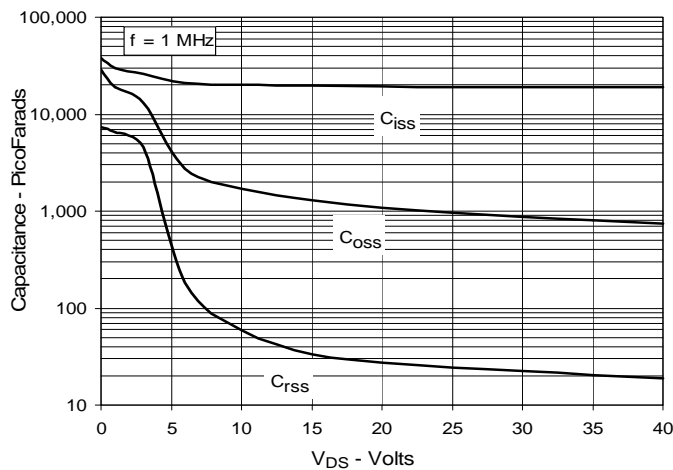
**Fig. 6. Maximum Drain Current vs.
Case Temperature**

Fig. 7. Input Admittance

Fig. 8. Transconductance

Fig. 9. Forward Voltage Drop of Intrinsic Diode

Fig. 10. Gate Charge

Fig. 11. Capacitance

Fig. 12. Maximum Transient Thermal Impedance
